

SEAT-PACK 16,5 L



- DE MONTAGEANLEITUNG
- GB ASSEMBLY INSTRUCTIONS
- FR INSTRUCTIONS DE MONTAGE
- IT ISTRUZIONI DI MONTAGGIO
- NL MONTAGE HANDLEIDING
- DK MONTERINGSVEJLEDNING

- ES INSTRUCCIONES DE MONTAJE
- SE MONTERINGSANVISNING
- NO MONTERINGSANVISNING
- FI ASENNUSOHJEET
- PL INSTRUKCJA MONTAZU
- JP 装着方法

ACCESSORIES

Support Strap for Seat-Pack = + Art. # E216

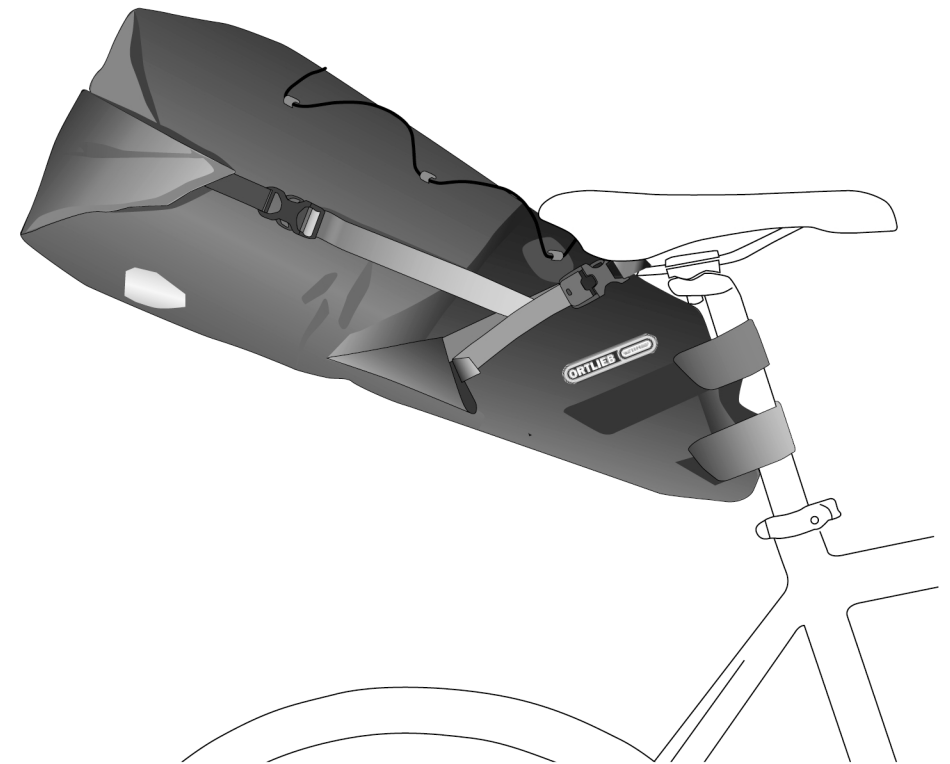
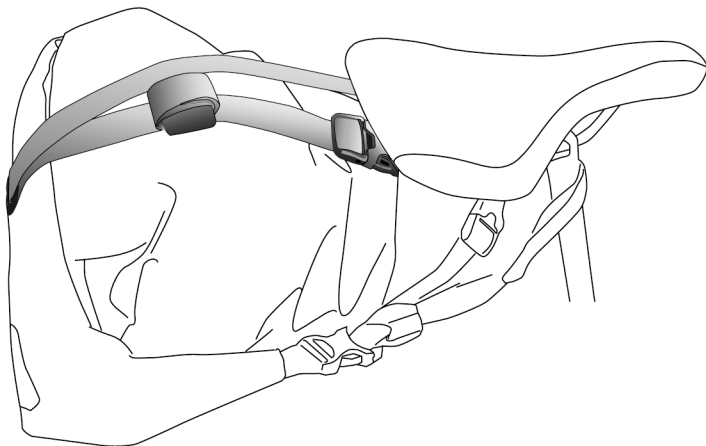
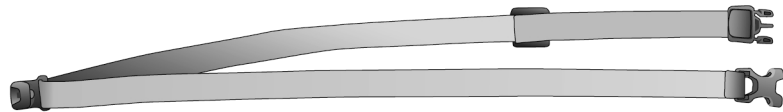

WEITERE INFORMATIONEN:

MORE INFORMATION:

<https://www.youtube.com/watch?v=CuMWYUYhSoM>

www.ortlieb.com



WA133 0820

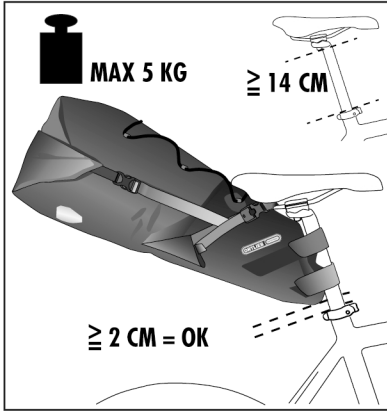

1.1

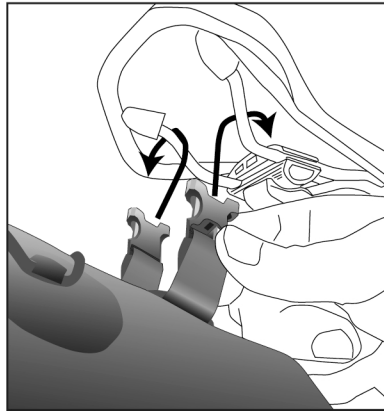

1.2

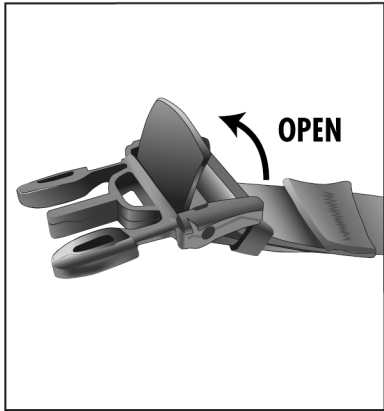

1.3

1.4

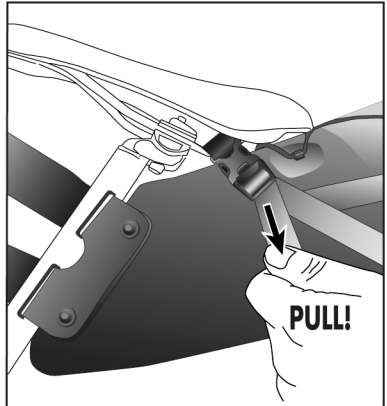

1.5

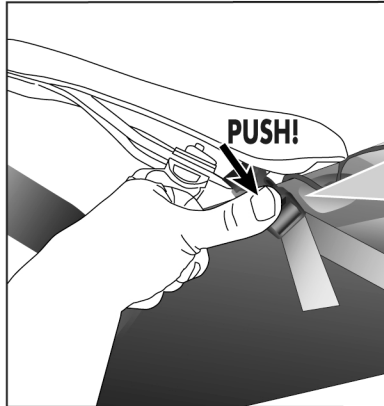

1.6

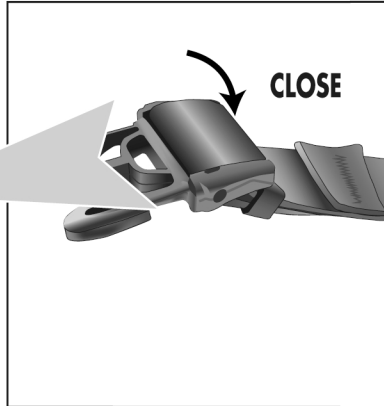

1.7

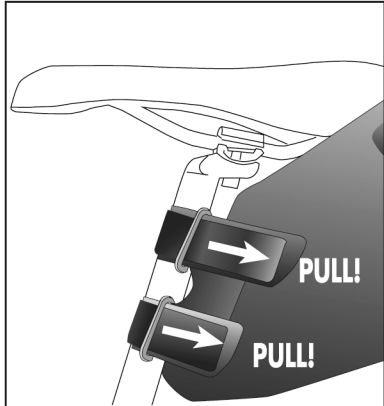

1.8

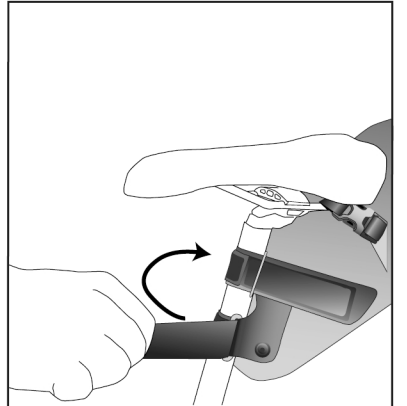

2.1

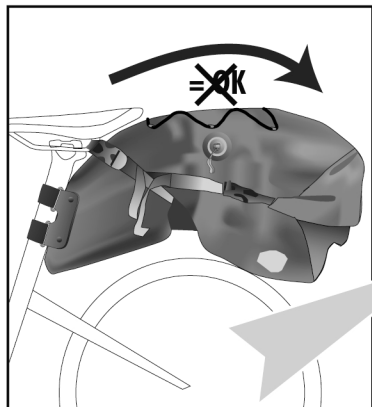

2.2

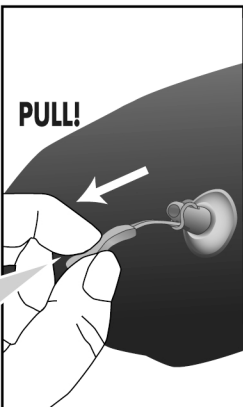

2.3

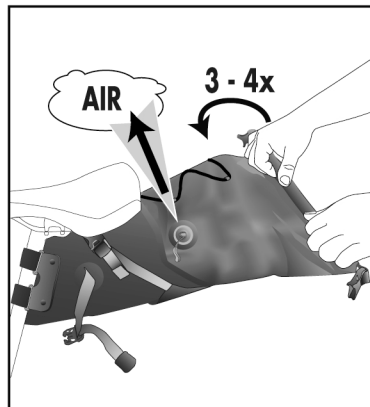

2.4

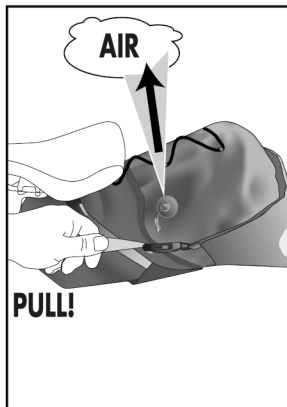

2.5

